

Rev No.	Description	Date	Name
A	New Part	05/05/2003	A.Vismara

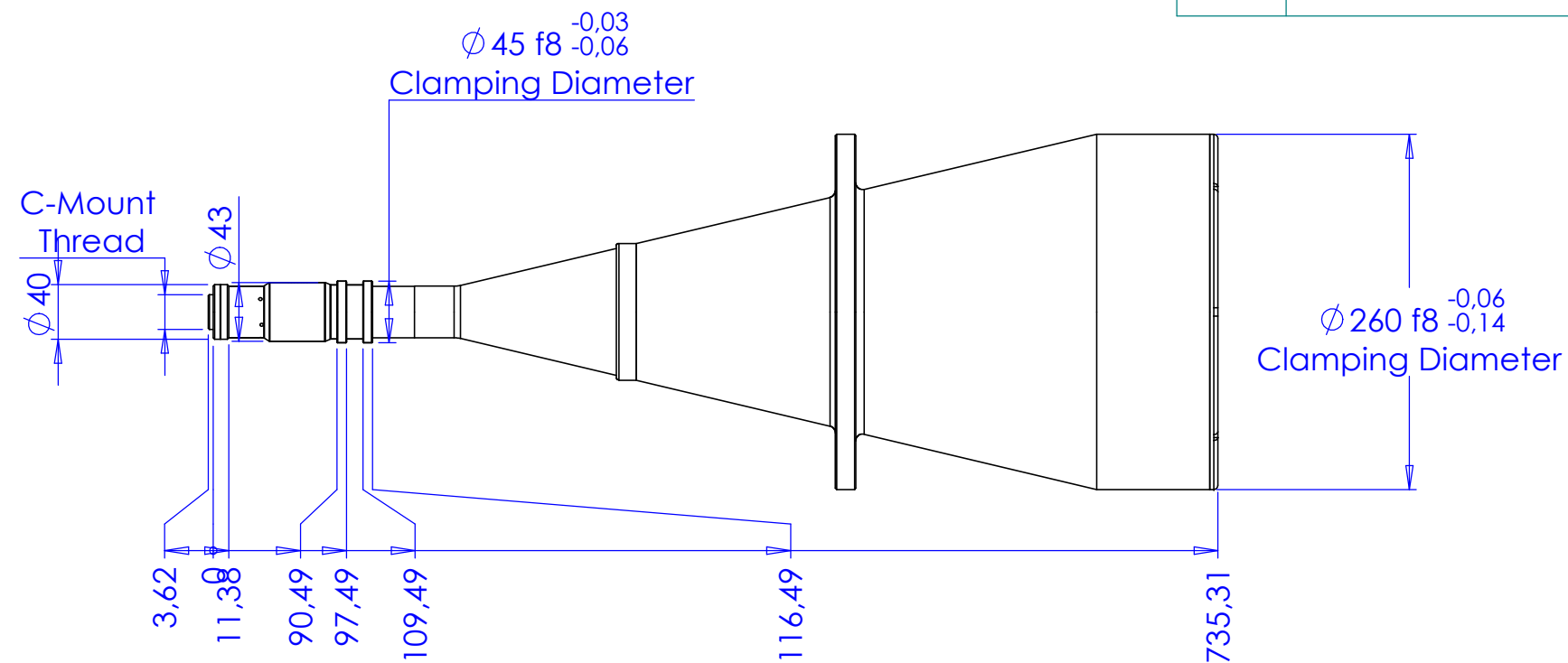

TC 4M 172/C
C-Mount

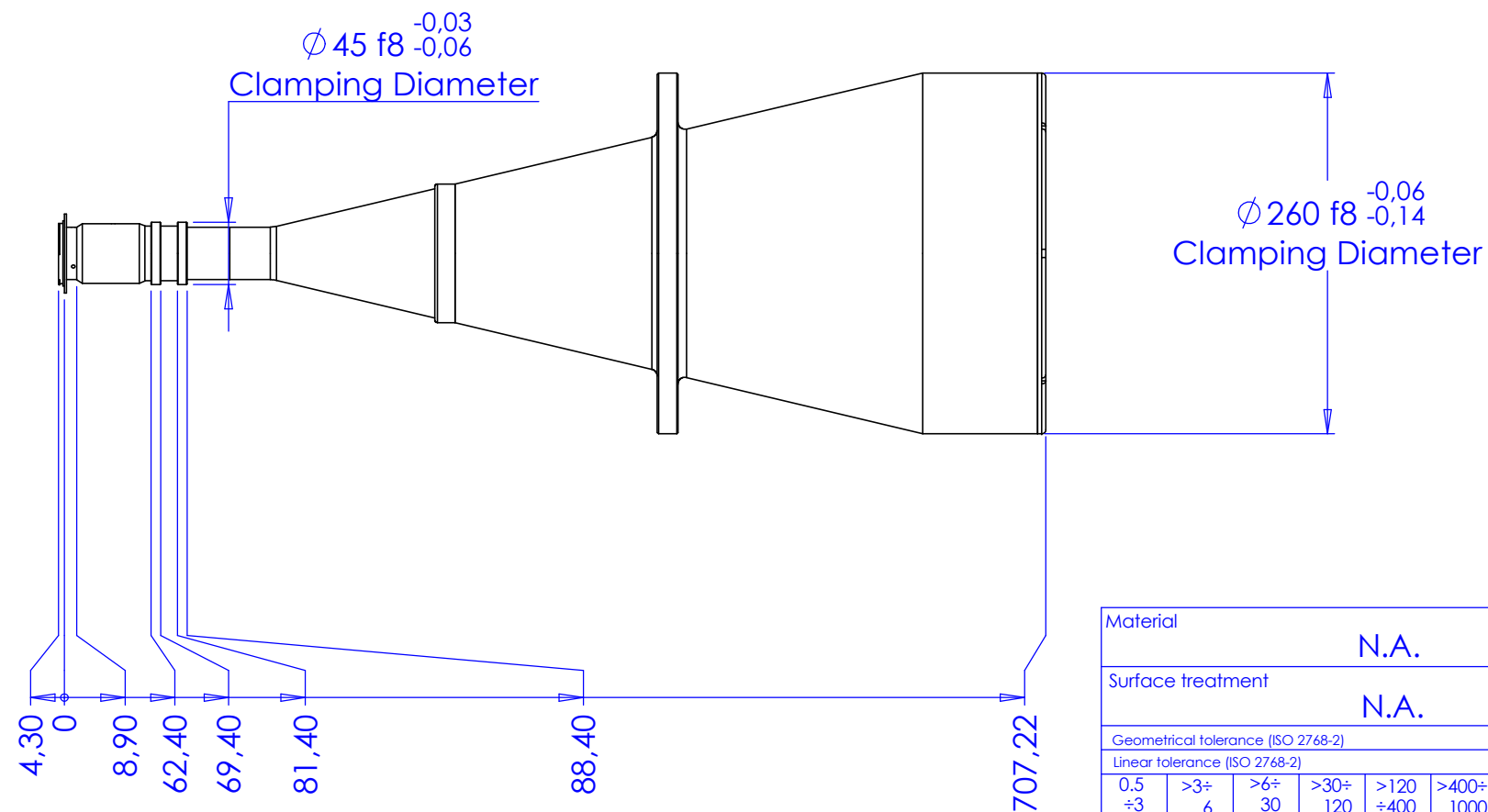

TC 4M 172/F
F-Mount

Material	N.A.		Mass	9181 g	Scale	1:5	
Surface treatment	N.A.		Project-Prod.item/Instrument TC 4M 172				
Geometrical tolerance (ISO 2768-2)		Class	K	Description			
Linear tolerance (ISO 2768-2)		Class	m	Undimensioned bevels	0.5x45°	Layout	
0.5 ±3	>3± 6	>6± 30	>30± 120	>120 ±400	>400± 1000		>1000 ±2000
±0.1	±0.1	±0.2	±0.3	±0.5	±0.8	±1.2	
				Undimensioned radii	R 0.5		
		Date	Name	Drawing No.			
		Designed	17/07/2006	A.Vismara	21575-0-A		Sheet
		Draw	17/07/2006	A.Vismara			1/1
		Checked	X	C. Sedazzari	Reproduction forbidden without specific authorization		
OPTO ENGINEERING S.R.L. - 46100 Mantova Italy - Via Cremona, 29/2 - Tel. +39 0376 263525 - e-mai: info@opto-engineering.com - http://www.opto-engineering.com							